

GCT 280H FLOOR DRAIN SKU:126-001-A000

Fixed height stainless steel floor drain (gully) for tiled, concrete and resin flooring in commercial kitchens, restaurants, supermarkets and food processing areas, etc. For applications where no waterproofing is used or waterproofing is independent of the floor drain body.

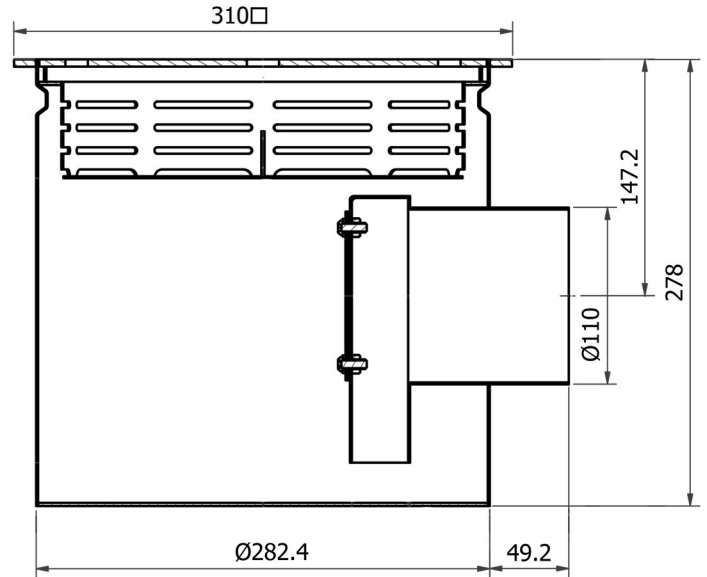

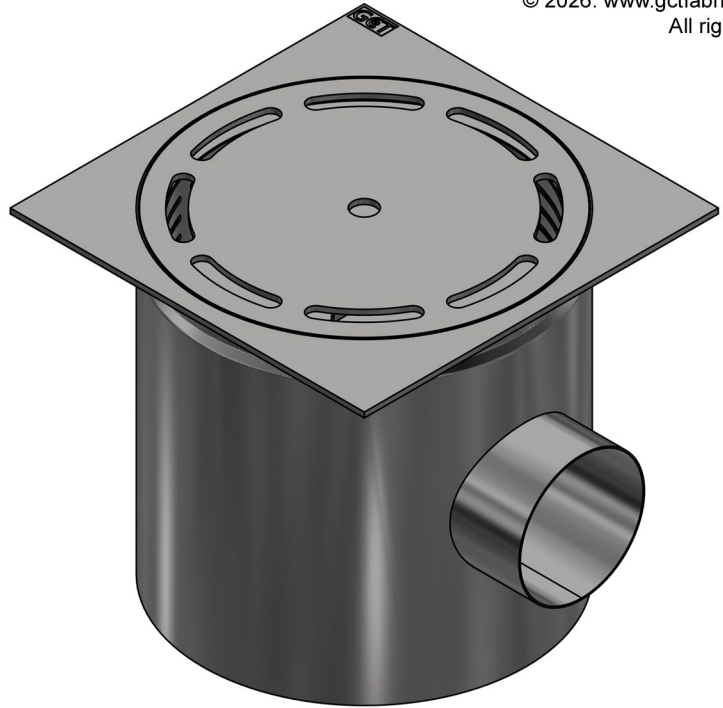



Specification

Standard (RSA): SANS 51253-1
Standard (EN): EN 1253-1
Floor: Tiles (square) or resin/ concrete (round)
Material (EN): 1.4301 (304) or 1.4404 (316)
Max flow (l/s): 4.5
Odour trap: Yes, integral, tamper-proof
Water seal height (mm): 50
Solids basket: Yes
Solids basket volume (l): 2.91
Surface finish: Pickled and passivated, polished
Membrane type: No membrane
Adjustable: No
Load class: 300KG (K3) or 2500KG (L15)
Number of screws: 2 (odour trap)
Gasket: Yes
Gasket material: NBR
Number of inlets: 0
Inlet/s diameter (mm): NA
Outlet direction: Horizontal
Outlet diameter (mm): 110
Minimum height (mm): 278
Body diameter (mm): 282
Overall dimensions (mm): 310 l X 359 w X 278 h
Weight (kg): 8.4



Order Sheet:

Please mark option/s in each box with an X. * (asterisk) indicates special order. If no options are selected the product is supplied as standard.

MATERIAL	LID TYPE	FLANGE SHAPE	FLANGE/ LID THICKNESS	SIDE INLET/S POSTION/S
select one X	select one X	select one X	select one X	select one to four X
<input type="checkbox"/> 304 <input type="checkbox"/> 316*	<input type="checkbox"/>  BETA LID <input type="checkbox"/>  BETA TUNDISH LID* <p>Note: Tundish funnel protrudes 93mm above the top of the floor drain.</p>	<input type="checkbox"/>  SQUARE (FOR TILES) <input type="checkbox"/>  ROUND* (FOR RESIN/ CONCRETE)	<input type="checkbox"/>  4.5MM <input type="checkbox"/>  10MM* <p>Note: As per SANS 51253-1, 4.5mm falls within load class K3, load tested @ 300KG. 10mm falls within load class L15, load tested @ 2500KG.</p>	NOT APPLICABLE

Qty:	Name:	Signature:	Date:	Company:	PO no:
------	-------	------------	-------	----------	--------