

GCT-IND CFI1000

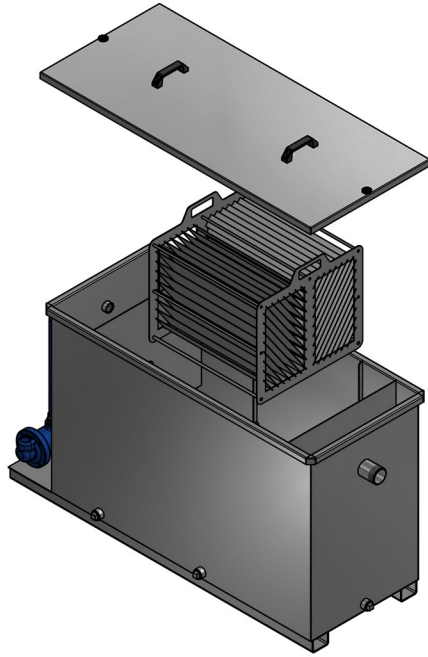

GCT-IND CFI1000 Oil-Water Separator

Features

Enhanced gravity separator for separation of all free/non-emulsified oils

- Advanced oil removal down to $\approx 5 - 10$ PPM with secondary polisher @ rated flow rate (**Optional**)
- Oil removal down to $\approx 10 - 20$ PPM @ rated flow rate
- Manufactured from 304 stainless steel (316 on special order)
- One (1) removable cross flow coalescer plate pack
- Adjustable gravity oil skim pipe for automatic skimming
- One (1) removable top cover with polyamide handles
- Suitable for above ground installations
- Pump, motor, float switches (**Optional**)
- SENS-OIL™ high oil level sensor and alarm (**Optional**)
- Tank anchor lugs (**Optional**)
- Designed to separate oils with a density of 0.91 g/cm^3
- Designed in accordance with API 421, Section 4

Rated Flow Rate: 1000L/hour (API 421 Standard)

Max Oil Capacity: ≈ 75 L (Automatic Skimming)

Net Weight: 115KG

General Applications:

Vehicle wash-bays, petro-chemical plants, refineries, substations & stormwater run-off treatment etc

