

GCT 200RE

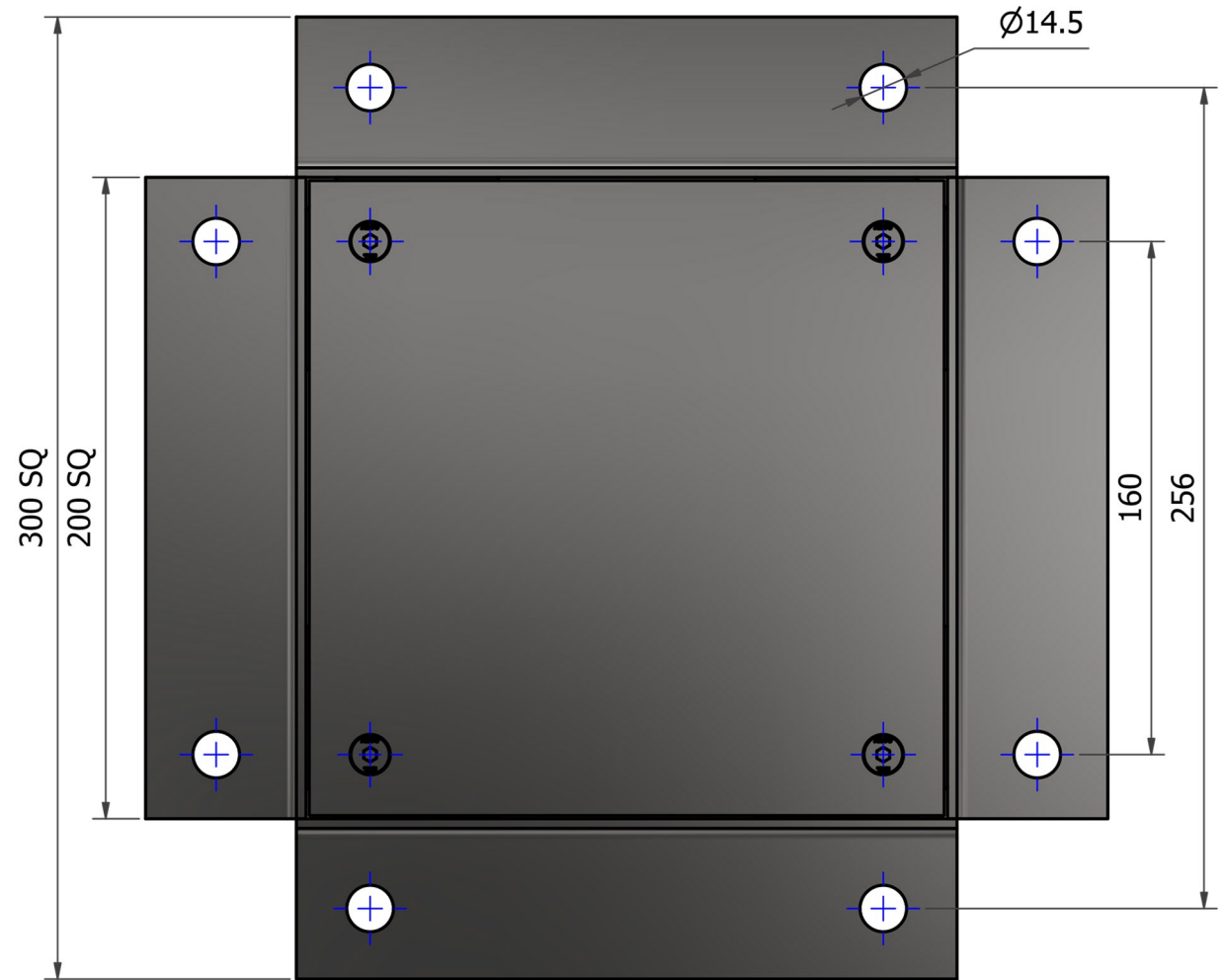
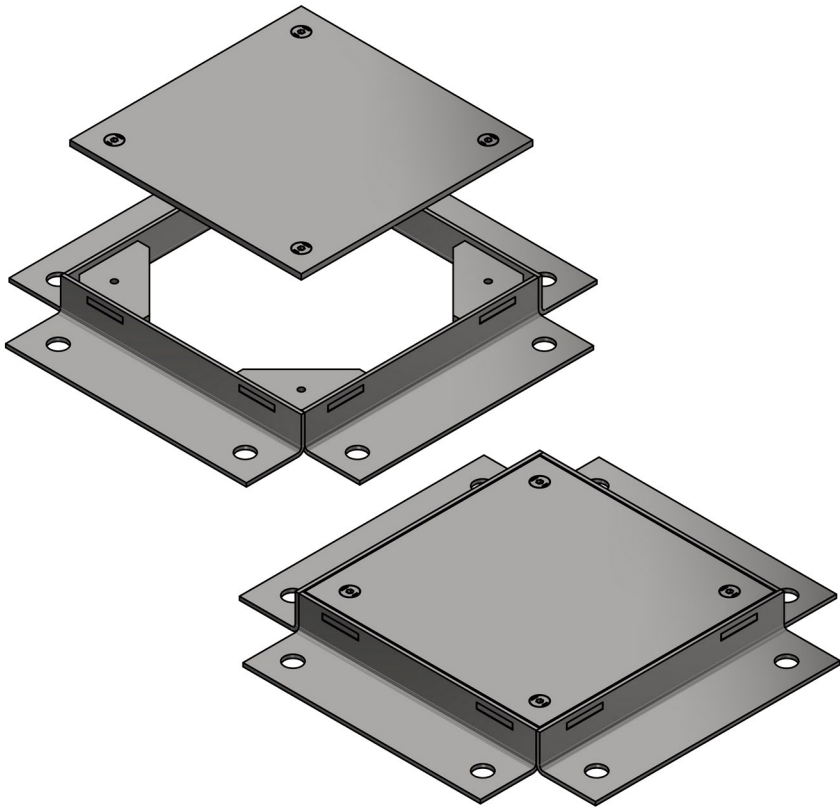

GCT 200RE Rodding Eye Cover

Features

- Manufactured from 304 stainless steel (316 on special order)
- External bolting flange
- Compatible with tiled floors
- Fully pickled/ passivated body
- Tamper-proof lid

Load Class: L15 (15kN)

Net Weight: 3.2KG

General Applications:

Hotels, hospitals, shopping malls, supermarkets, hypermarkets etc

