

# GCT 200IRE

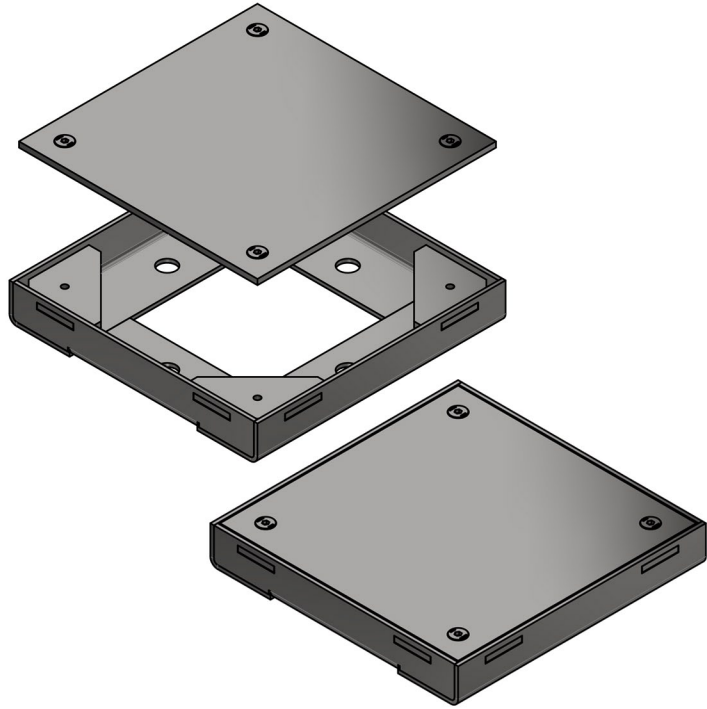

## GCT 200IRE Rodding Eye Cover

### Features

- Manufactured from 304 stainless steel (316 on special order)
- Internal bolting flange
- Compatible with epoxy floors
- Fully pickled/ passivated body
- Tamper-proof lid

**Load Class:** L15 (15kN)

**Net Weight:** 3.2KG

### General Applications:

Hotels, hospitals, shopping malls, supermarkets, hypermarkets etc

